

Premium MR16 LED Bulb

Dimmable

- Leading edge dimmer ✓
- Trailing edge dimmer ✓



MR16 7W-50W Dimmable LED Spotlight

- ✓ Standard size lamps
- ✓ Built-in high compatibility dimmable driver
- ✓ For commercial application, 24 hours working
- ✓ COB inside, high efficiency, high CRI
- ✓ Fixed height does not affect assembly
- ✓ Compliant with EMC / LVD / RoHS



RA98 LM80



Article Code TMR16FIN-7W-XD

GENERAL CHARACTERISTICS

Shape	GU5.3
Cap - Base	MR16
Rated Wattage	7 W
Input Voltage	12 Vac
Operation Frequency	50/60 Hz
Lifetime (hours)	40,000 hrs
Switching Cycles	50,000
Start Time from 0% to 100%	< 0.2 s
Power Factor	0.9
Working Temperature	-20°C ~ 40°C
Guarantee	3 years
Dimension	W:50mm x H:47mm

LIGHT CHARACTERISTICS

Color	Warm white / Cool white
Luminous Flux	440lm / 480lm / 520lm
Color Temperature	2700 K / 3000 K / 4000 K
Color Rendering Index	98
Lamp Efficacy	up to 80 lm/W
Lumen Maintenance Factor	70%
Beam Angle	24D/36D/60D
Dimming Type	Phase Cutting (triac)
Color Consistency	3 Step MacAdam Ellipse
Wattage Equivalent to Halogen	70W

TECO

inspired by technology

www.tecolite.com
sales@tecolite.com
Huizhou Henhui Electronics Technology Co., Ltd.

Illuminance diagram

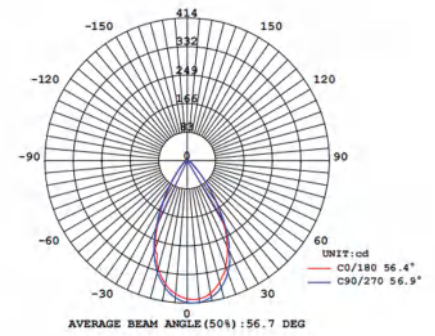
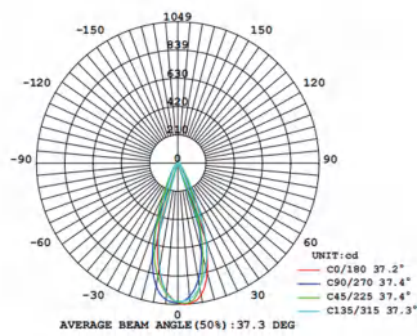
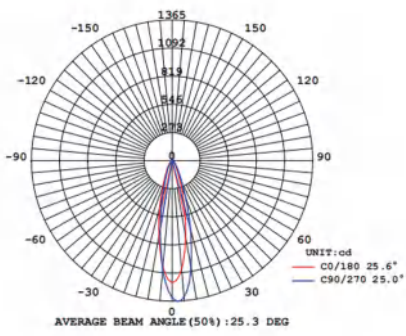

PHOTOMETRIC DATA

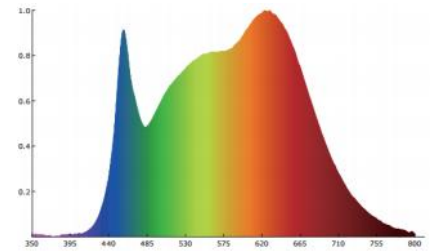
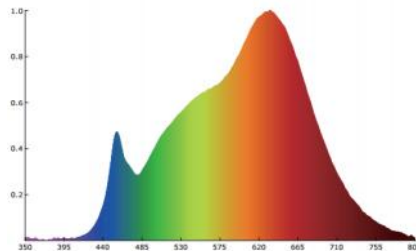
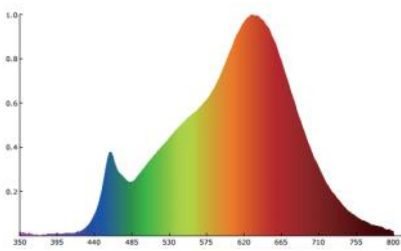

Dimensional drawing

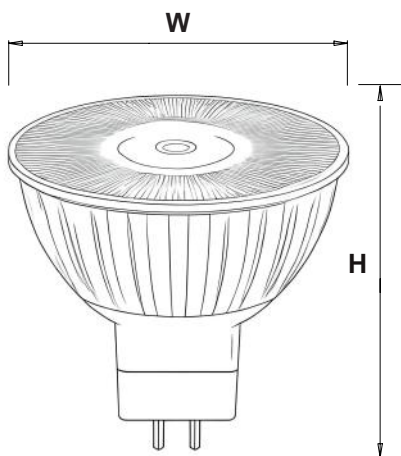

Product	W	H
TMR16FIN-7W-XD	50 mm	47 mm